

Hall Effect Current Sensors L07P***D15 Series

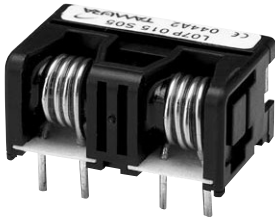

Features:

- Open Loop type
- Dual integrated primary
- Bipolar power supply
- Printed circuit board mounting
- Insulated plastic case according to UL94V0
- UL Recognition

Advantage:

- Excellent accuracy and linearity
- Wide nominal current range
- Low temperature drift
- Wide frequency bandwidth
- No insertion loss
- High Immunity To External Interference
- Optimised response time
- Current overload capability

Specifications

 $T_A=25^{\circ}\text{C}, V_{CC}=\pm 15\text{V}, R_L=10\text{k}\Omega$

Parameters	Symbol	L07P003D15	L07P005D15	L07P010D15	L07P015D15	L07P020D15	L07P025D15	L07P030D15
Primary nominal current	I_f	3A	5A	10A	15A	20A	25A	30A
Saturation current	I_{fmax}	$\geq \pm I_f \times 3$						
Rated output voltage	V_o	$4\text{V} \pm 0.060\text{V}$ (at I_f)						
Offset voltage ¹	V_{of}	$\leq \pm 0.060\text{V}$ (at $I_f = 0\text{A}$)						
Output linearity ² (0A~ I_f)	ϵ_L	$\leq \pm 1\%$ (at I_f)						
Power supply voltage	V_{CC}	$\pm 15\text{V} \pm 5\%$						
Consumption current	I_c	$\leq \pm 30\text{mA}$						
Response time ³	t_r	$\leq 5\mu\text{s}$ (at $di/dt = I_f / \mu\text{s}$)						
Thermal drift of gain ⁴	$TcVo$	$\leq \pm 0.1\% / ^{\circ}\text{C}$						
Thermal drift of offset	$TcVof$	$\leq \pm 2.5\text{mV} / ^{\circ}\text{C}$						
Hysteresis error	V_{OH}	$\leq 30\text{mV}$ (at $I_f = 0\text{A} \rightarrow I_f \rightarrow 0\text{A}$)						
Insulation voltage	V_d	AC2000V for 1minute (sensing current 0.5mA), primary \leftrightarrow secondary						
Insulation resistance	R_{IS}	$\geq 500\text{M}\Omega$ (at DC500V), primary \leftrightarrow secondary						
Ambient operation temperature	T_A	$-30^{\circ}\text{C} \sim +80^{\circ}\text{C}$						
Ambient storage temperature	T_S	$-40^{\circ}\text{C} \sim +85^{\circ}\text{C}$						

¹ After removal of core hysteresis — ² Without offset — ³ Time between 10% input current full scale and 90% of sensor output full scale. each channel's value, non-measured circuit is set to 0A. — ⁴ Without Thermal drift of offset

Electrical Performances

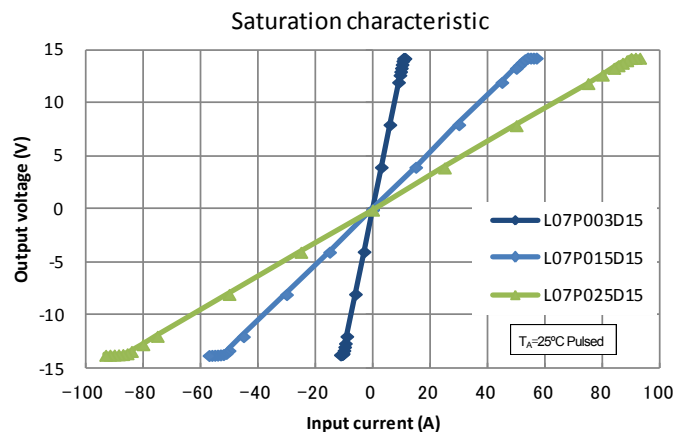
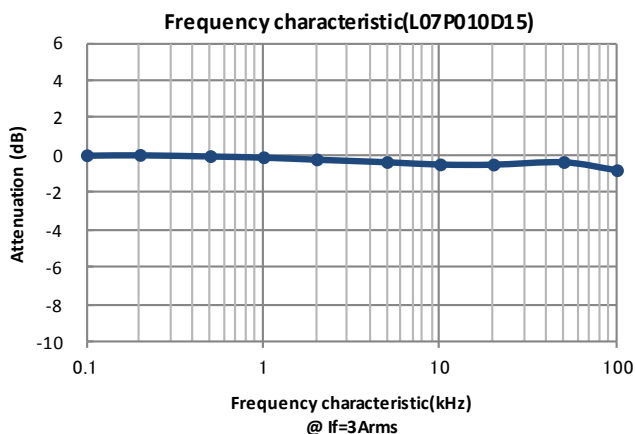

Hall Effect Current Sensors L07P***D15 Series

Mechanical dimensions

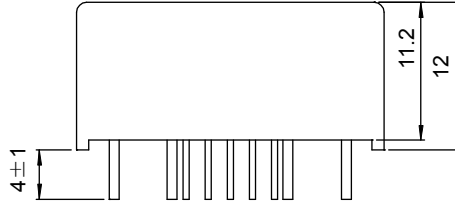
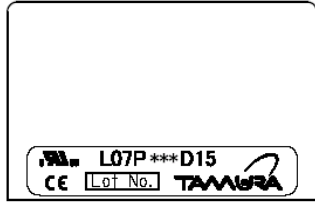

NOTES

1. Unit is mm
2. Tolerance is 0.5mm

A	φD
3A	φ0.6
5A	φ0.8
10~15A	φ1.4
20~30A	φ1.6

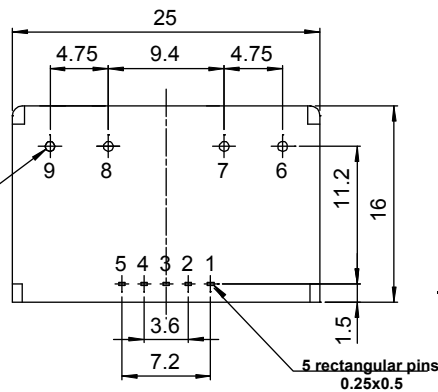

Terminal	Function
1	+V _{CC} (+15V)
2	-V _{CC} (-15V)
3	V _{OUT1}
4	V _{OUT2}
5	GND
6	Primary input current1 (+)
7	Primary input current1 (-)
8	Primary input current2 (+)
9	Primary input current2 (-)

Electrical connection diagram

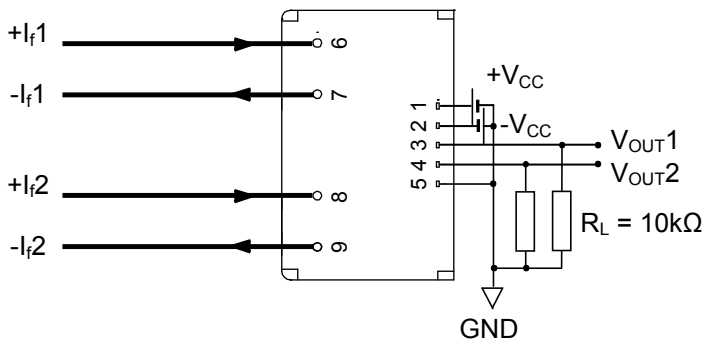

UL Standard

UL 508 , CSA C22.2 No.14
(UL FILE No.E243511)

- For use in Pollution Degree 2 Environment.
- Maximum Surrounding air temperature rating, 80°C.

Package & Weight Information

Weight	Pcs/box	Pcs/carton	Pcs/pallet
12g	100	400	12800

Mouser Electronics

Authorized Distributor

Click to View Pricing, Inventory, Delivery & Lifecycle Information:

[Tamura:](#)

[L07P005D15](#) [L07P010D15](#) [L07P003D15](#) [L07P015D15](#) [L07P025D15](#) [L07P020D15](#) [L07P030D15](#)