



HORIZONTAL LIQUID LEVEL SENSORS

LS Series

High- or low-level switching

N.O./N.C. SPST or SPDT outputs

Mounted on the side wall of a tank

Certified reed switch (UL component listed)

Choice of several non-reactive wetted materials

Many different configurations available

Features

- Voltage rating up to 250VAC
- Current rating up to 1.0 amp
- Compact design and low profile
- Optional cable lengths
- Includes mounting hardware

Applications

- Water and fuel storage tanks
- Full and/or empty detection
- Pump on/off controls
- Marine bilge and ballast tanks
- Flood detection and prevention
- Coolant level indication
- Livestock watering tanks
- Irrigation systems
- Water treatment plants
- Waste water tanks
- Chemical storage and processing

The LS series of point liquid level switches demonstrates a high degree of reliability due to the use of non-reactive wetted components and a unique reed switch designed specifically for level sensing applications. The sensor utilizes a moving float with an embedded magnet to activate a reed switch located in the sensor body. As the liquid level raises the float, it moves into close proximity to the reed switch and actuates it to give an open contact or closed contact switch indication.

The reliability of this sensor results from a very simple operating principle, a single moving part, media compatible wetted materials, and a unique reed switch design that has a UL recognized component certification.

The sensor mounts into the side wall of a liquid storage tank using either a 1/2" NPT or M16 x 2.0 threaded fitting. The M16 mount is available in either an internal or external configuration. The output is a simple N.O. or N.C. SPST, or SPDT reed switch that utilizes Ruthenium contact points for reliability. Changing from a N.O. output to a N.C. output is done by rotating the switch 180° in the mounting hole. This change can be done in the field. Electrical outputs are a single pair of wires with PVC insulation and optional lengths of 0.5 m or 2.0 m.

[CLICK HERE >](#)
CONNECT WITH A SPECIALIST

LIQUID LEVEL SWITCH

LS SERIES

Absolute Maximum Ratings ⁽¹⁾

Parameter	Min	Max	Units	Notes/Conditions
DC contact voltage (SPST)		100	V	Do not exceed 70W
DC contact current (SPST)		1.0	A	
RMS contact voltage (SPST)		250	V	
RMS contact current (SPST)		1.0	A	
DC contact voltage (SPDT)		170	V	Do not exceed 5.0W
DC contact current (N.O. SPDT)		0.4	A	
DC contact current (N.C. SPDT)		0.125	A	
RMS contact voltage (SPDT)		125	V	
RMS contact current (SPDT)		0.125	A	
Operating and storage temperature	-30	110	°C	
Fitting pressure	-1.0	4.0	Bar	Internal tank pressure
Tank wall thickness (Internal mount)	1.0	10	mm	
Tank wall thickness (External mount)	1.0	4.0	mm	

⁽¹⁾ Maximum limits the device will withstand without damage

Product Specifications

Parameter	Details & Options
Mounting Orientation	Side entry
Fitting	Internal or External
Switch Operation	N.C. when float is horizontal
Contact Forms	Form A (SPST) or Form C (SPDT)
Contact Material	Ruthenium
Contact resistance (max)	140 mΩ
Housing and Float Material	Glass filled nylon 6.6 (better for oil, fuel, non-ionic liquids) Glass filled PPS (better for water and aqueous solutions) Glass filled Polypropylene (better for water and aqueous solutions)
Cable Description	18 AWG 32/0.2mm PVC insulated, UL/CSA/BS6361
Shock	±50g 11ms half sign duration
Vibration	±35g 0 – 500Hz
Ambient Humidity	0 – 95% RH (non-condensing)
Ingress protection	IP68 (wetted surfaces) IP65 (non-wetted surfaces)
Approvals & Certifications	UL file E98428

LIQUID LEVEL SWITCH

LS SERIES

Outline Dimensions

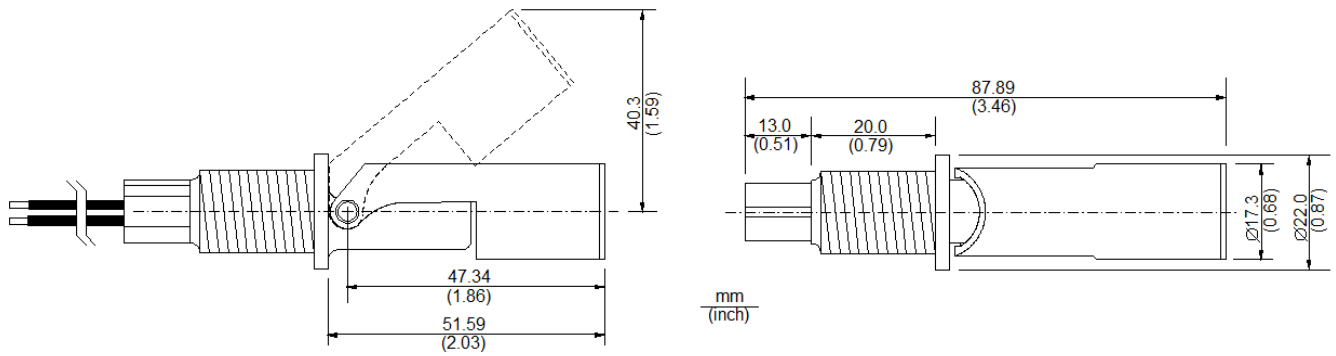

Schematic

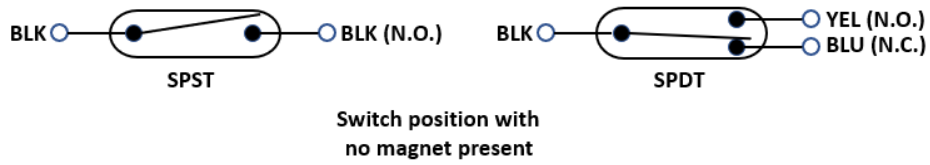

LIQUID LEVEL SWITCH

LS SERIES

Mounting Orientations

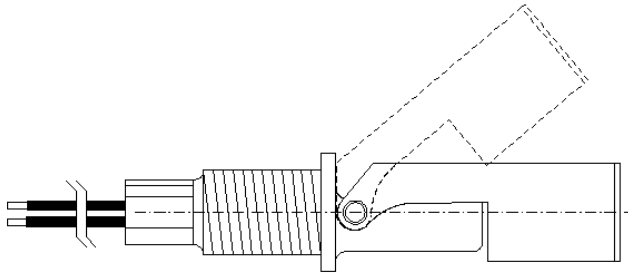

Condition	Switch (SPST)
No liquid	Closed
Liquid	Open

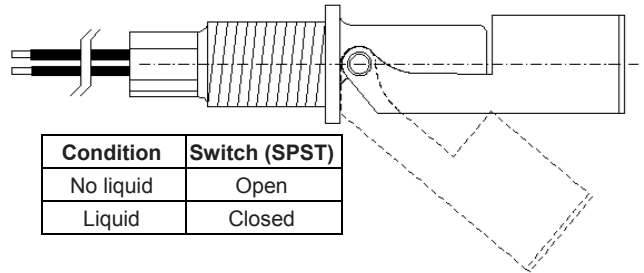

Condition	Switch (SPST)
No liquid	Open
Liquid	Closed

Mounting Detail & Hardware

INTERNAL FITTING

CONTAINER WALL
(THICKNESS MAX 10mm, MIN 1mm)

NOTE! DRILL 0.65" OR 16.5mm HOLE,
ENSURE FREE FROM SWarf AND
SHARP EDGES.

LOCK WASHER

FIXING NUT

NOTE! MAX TORQUE 3lbs/ft
OR 4Nm.

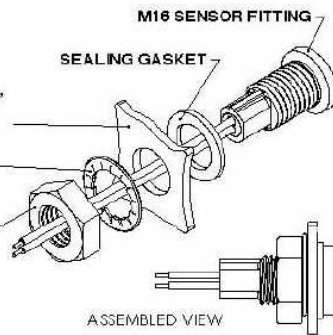

EXTERNAL FITTING

CONTAINER WALL
(THICKNESS MAX 4mm, MIN 1mm)

NOTE! DRILL 0.9" OR 23mm HOLE,
ENSURE FREE FROM SWarf AND
SHARP EDGES.

SEALING GROMMET

FRICTION RELIEF
WASHER

FIXING NUT

NOTE! MAX TORQUE 2lbs/ft
OR 2.67Nm.

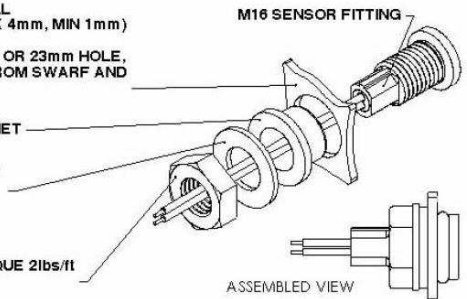

LIQUID LEVEL SWITCH

LS SERIES

Ordering Information

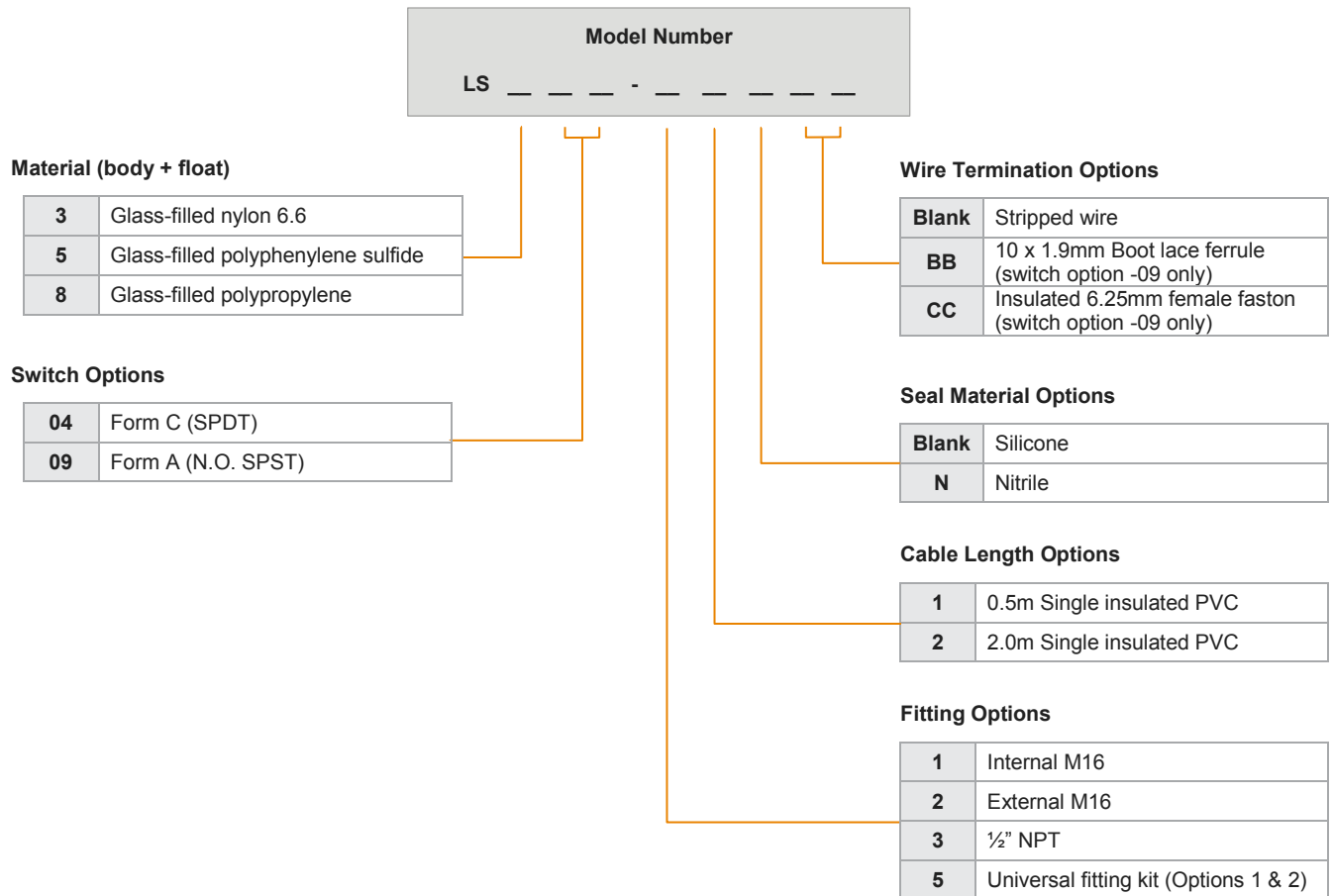

[CLICK HERE >](#)
CONNECT WITH A SPECIALIST

NORTH AMERICA
Tel +1 800 522 6752

EUROPE
Tel +31 73 624 6999

ASIA
Tel +86 0400 820 6015

te.com/sensors

TE Connectivity, TE, TE Connectivity (logo) and Every Connection Counts are trademarks. All other logos, products and/or company names referred to herein might be trademarks of their respective owners

The information given herein, including drawings, illustrations and schematics which are intended for illustration purposes only, is believed to be reliable. However, TE Connectivity makes no warranties as to its accuracy or completeness and disclaims any liability in connection with its use. TE Connectivity's obligations shall only be as set forth in TE Connectivity's Standard Terms and Conditions of Sale for this product and in no case will TE Connectivity be liable for any incidental, indirect or consequential damages arising out of the sale, resale, use or misuse of the product. Users of TE Connectivity products should make their own evaluation to determine the suitability of each such product for the specific application.

© 2020 TE Connectivity Corporation. All Rights Reserved.

10/2020

Mouser Electronics

Authorized Distributor

Click to View Pricing, Inventory, Delivery & Lifecycle Information:

[TE Connectivity:](#)

[80650-000](#)