

**SERIES:** ACZ11 | **DESCRIPTION:** MECHANICAL INCREMENTAL ENCODER**ELECTRICAL SPECIFICATIONS**

parameter	conditions/description
output waveform	square wave
output signals	A, B phase
current consumption	10 mA
output phase difference	T1, T2, T3, T4 $\geq$ 3.5 ms @ 60 rpm (see output waveform)
supply voltage	5 V dc max.
output resolution	12, 15, 20, 30 ppr
switch rating	12 V dc, 50 mA (ACZ11BRXE models only)
insulation resistance	300 V dc, 100 M $\Omega$
withstand voltage	300 V ac

**MECHANICAL SPECIFICATIONS**

parameter	conditions/description	min	nom	max	units
shaft load	axial			8	kgf
rotational torque	with detent click	60	140	220	gf•cm
	without detent click	60	80	100	gf•cm
push switch operational force	(ACZ11BRXE models only)	300		900	gf•cm
push switch life	(ACZ11BRXE models only)			50,000	cycles
rotational life				30,000	cycles

**ENVIRONMENTAL SPECIFICATIONS**

parameter	conditions/description	min	nom	max	units
operating temperature		-10		65	°C
storage temperature		-40		75	°C
humidity		85			% RH
vibration	0.75 mm max. travel for 2 hours	10		55	Hz

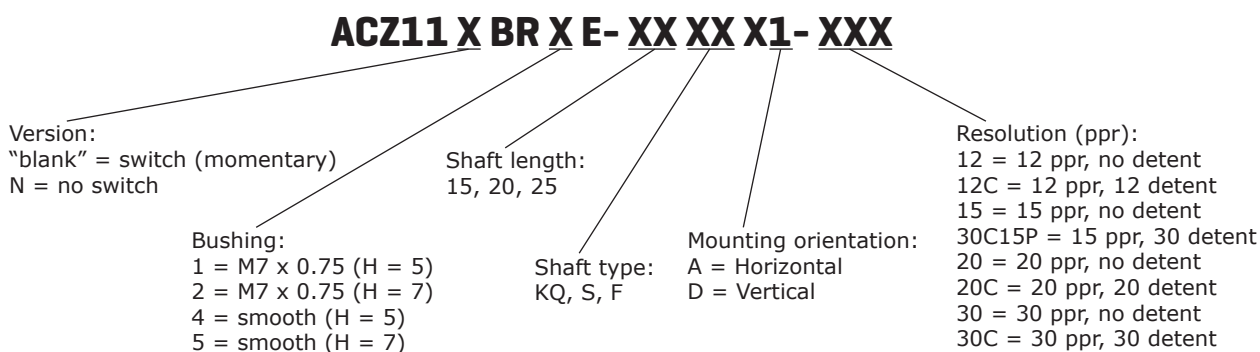
**PART NUMBER KEY**

## SHAFT OPTIONS

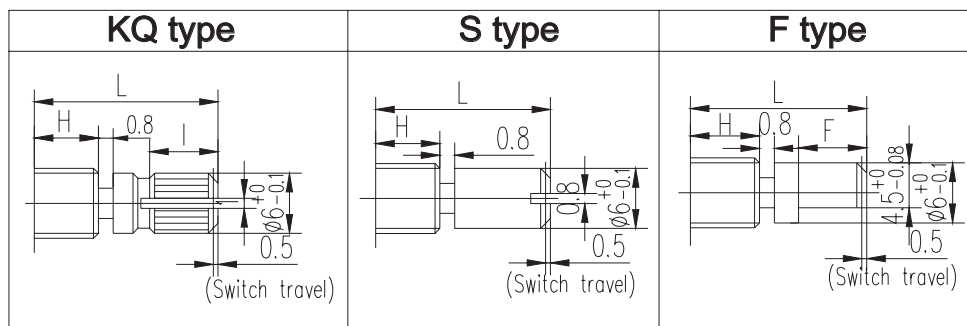

BUSHING		
Condition	H	
1 M7-P0.7	5	5
2 M7-P0.7	5	7
4 smooth	5	
5 smooth	7	

switch travel for ACZ11BRXE only

H=5

	15KQ	20KQ	25KQ
L	15	20	25
I	7	10	12

H=5

	15S	20S	25S
L	15	20	25

H=5

	15F	20F	25F
L	15	20	25
F	8	12	12

H=7

	15KQ	20KQ	25KQ
L	15	20	25
I	5	8.5	10

H=7

	15S	20S	25S
L	15	20	25

H=7

	15F	20F	25F
L	15	20	25
F	8	12	12

## OUTPUT WAVEFORM

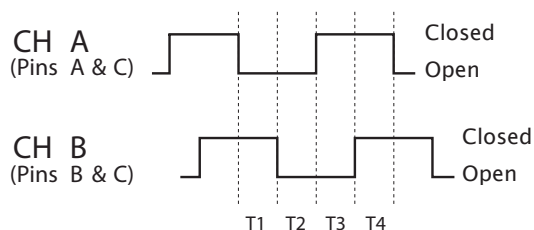

CW direction (@ 60 rpm)

## DETENT POSITIONS

### Model 12C & 20C

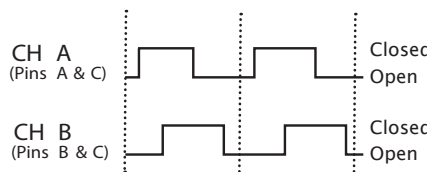

CW direction →

### Model 15P30C

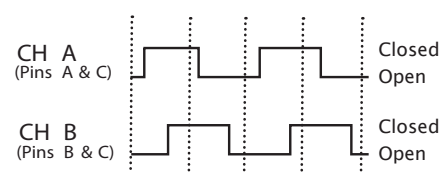

CW direction →

## SLIDING NOISE

$t =$  Masking time to avoid chatter (5mS)  $V_1 = V_2 = 1V$  max.

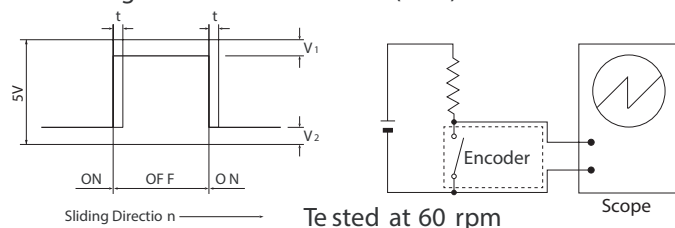

## SUGGESTED FILTER

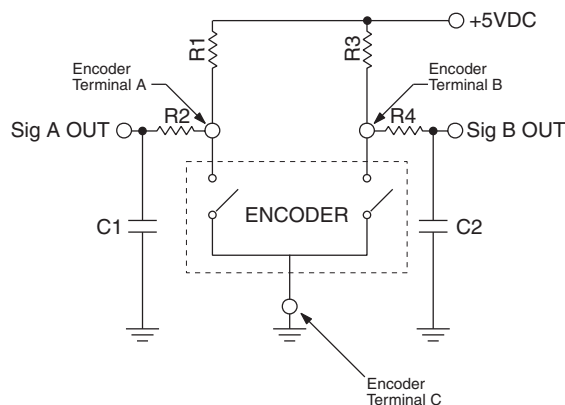

R1, R2, R3, R4 = 10kΩ  
C1, C2 = 0.01μF

## MECHANICAL DRAWING (horizontal)

ACZ11NBRXE

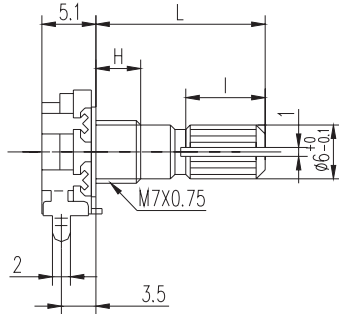
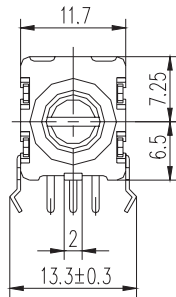

PANEL CUT-OUT

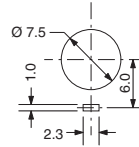

PCB LAYOUT

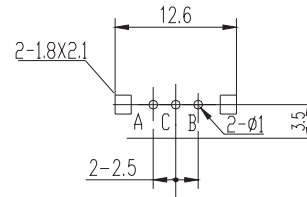

ACZ11BRXE

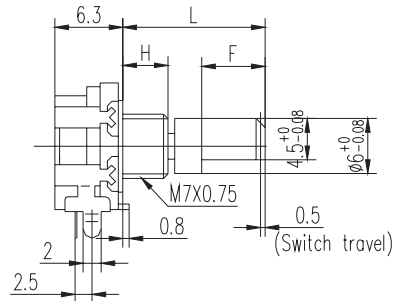
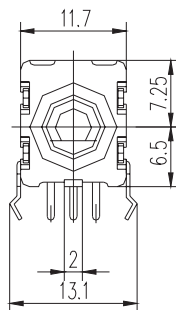

PANEL CUT-OUT

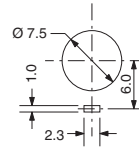

PCB LAYOUT

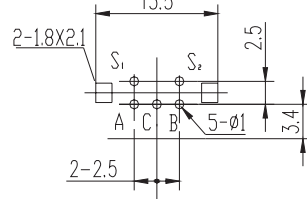

## MECHANICAL DRAWING (vertical)

ACZ11NBRXE

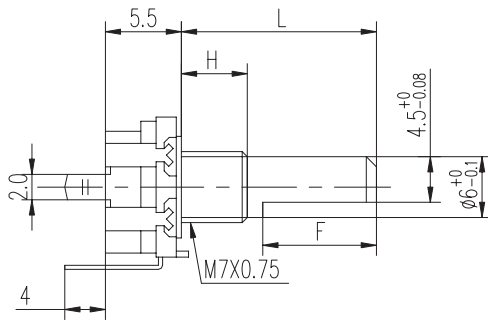
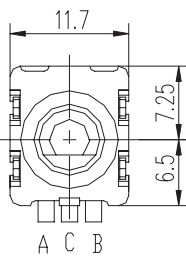

PANEL CUT-OUT

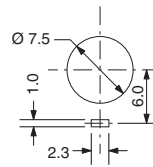

PCB LAYOUT

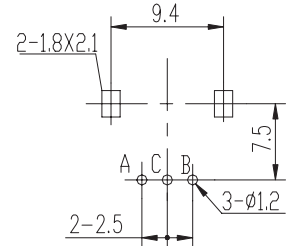

ACZ11BRXE

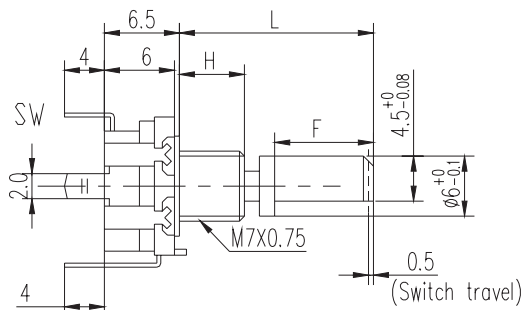
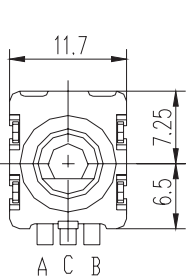

PANEL CUT-OUT

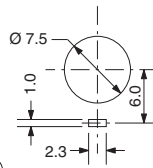

PCB LAYOUT

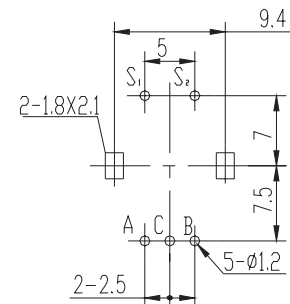

## REVISION HISTORY

---

rev.	description	date
1.0	initial release	10/30/2009
1.01	brand update	10/04/2019
1.02	updated datasheet	06/15/2020

The revision history provided is for informational purposes only and is believed to be accurate.

---

# CUI DEVICES

CUI Devices offers a one (1) year limited warranty. Complete warranty information is listed on our website.

CUI Devices reserves the right to make changes to the product at any time without notice. Information provided by CUI Devices is believed to be accurate and reliable. However, no responsibility is assumed by CUI Devices for its use, nor for any infringements of patents or other rights of third parties which may result from its use.

CUI Devices products are not authorized or warranted for use as critical components in equipment that requires an extremely high level of reliability. A critical component is any component of a life support device or system whose failure to perform can be reasonably expected to cause the failure of the life support device or system, or to affect its safety or effectiveness.

# Mouser Electronics

Authorized Distributor

Click to View Pricing, Inventory, Delivery & Lifecycle Information:

## CUI Devices:

[ACZ11BR1E-15FD1-20C](#) [ACZ11BR1E-15FD1-12C](#) [ACZ11BR1E-20KQD1-20C](#) [ACZ11BR1E-15FA1-12C](#)  
[ACZ11BR1E-15KQD1-20C](#) [ACZ11BR1E-20FD1-20C](#) [ACZ11BR1E-20FD1-12C](#) [ACZ11BR1E-20FA1-20C](#)  
[ACZ11BR1E-15FA1-20C](#) [ACZ11BR1E-15KQA1-12C](#) [ACZ11BR4E-15FA1-20C](#) [ACZ11BR4E-20KQD1-12C](#)  
[ACZ11BR4E-20KQD1-20C](#) [ACZ11BR4E-15FD1-20C](#)